



# Fiat 500 Abarth - Fuel Filler Door - Chrome



Fuel Filler Door



Torque Wrench



Phillips Driver



xxmm



13mm



10mm



8mm

1



2



xxmm

3 Remove filler cap.



4

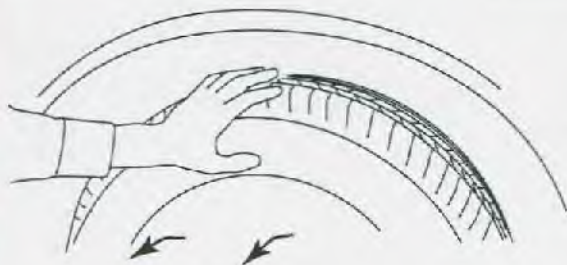

Raise vehicle and remove rear wheel using xxmm socket.

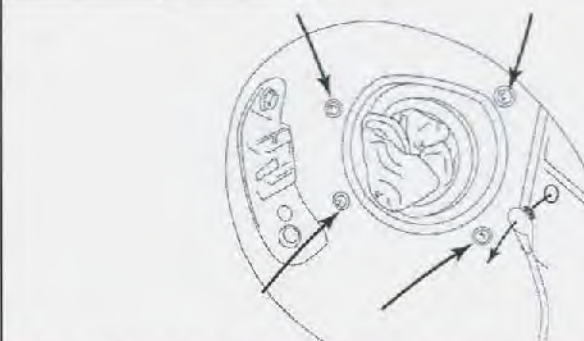

Place cloth rag in filler pipe. Remove filler cap tether. Using Phillips screwdriver, remove four filler neck screws.

5

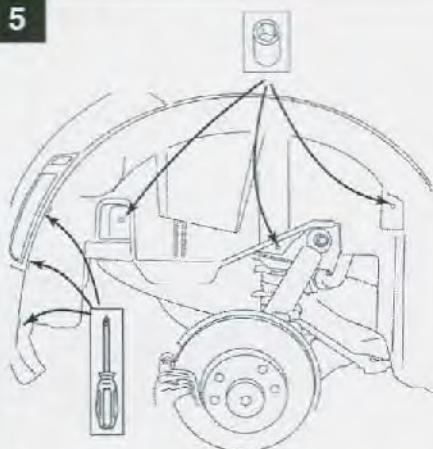

13mm

Remove three fasteners at rear of wheel opening using a Phillips screwdriver. Use a 13mm socket to remove three fasteners as shown.

6

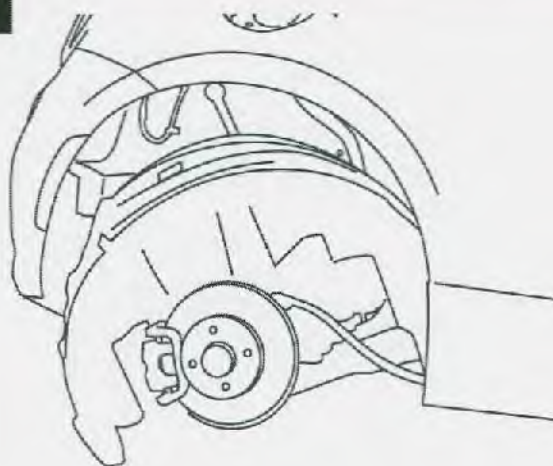

Lower fender liner to gain access to fuel filler area.

7

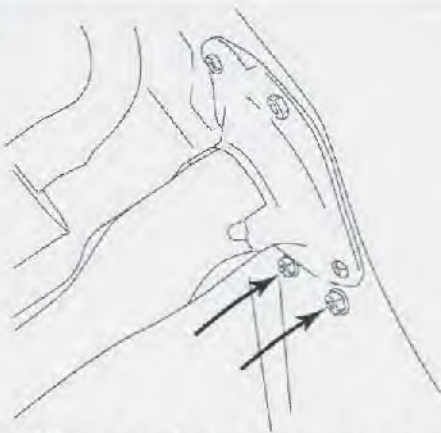

10mm

Using 10mm socket, remove two nuts holding stock door in place.

8

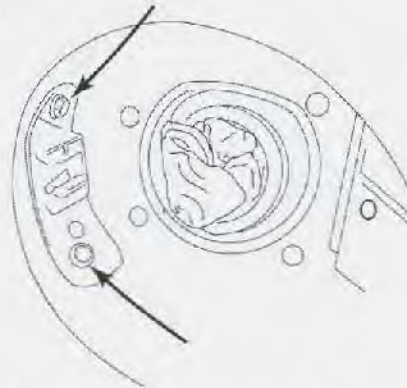

8mm

Using 8mm socket remove two fasteners holding striker plate and remove striker plate.

9

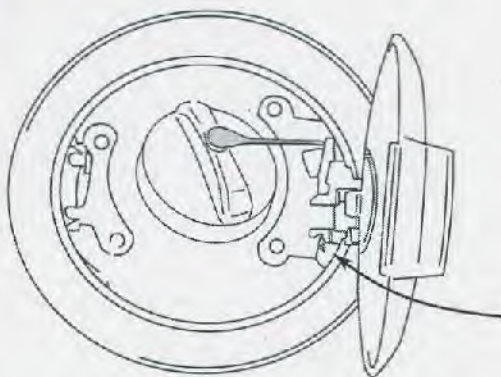

Reattach fuel filler tether to fuel filler door. Tether cord is to be routed behind mounting bracket as shown.

10

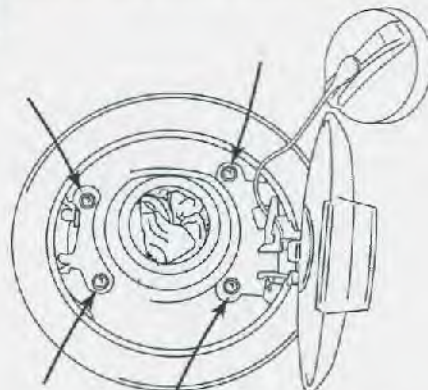

Insert filler door and reattach using 4 Phillips head screws removed from step 4. Torque screws to xx in-lbs.

11

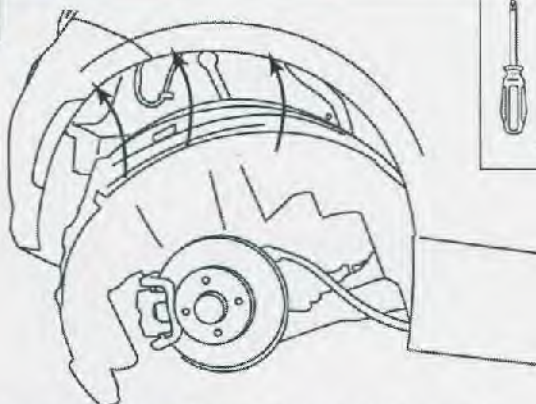

13mm

Reinsert fender liner into position and reattach three Phillips screws and three 13mm fasteners removed in step 5.

12

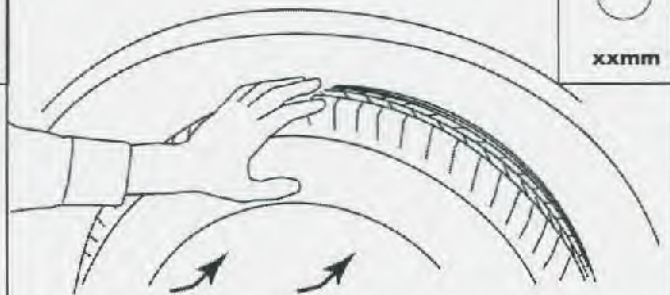

xxmm

Reinstall rear wheel. Torque wheel nuts to xx ft-lbs using xxmm socket and lower vehicle.



# Fiat 500 Abarth – Porte de réservoir de carburant - Chrome



Porte de réservoir de carburant



Clé dynamométrique



Tournevis cruciforme



xxmm



13mm



10mm



8mm

1



2



xxmm

3

Retirer le bouchon du réservoir de carburant.



4

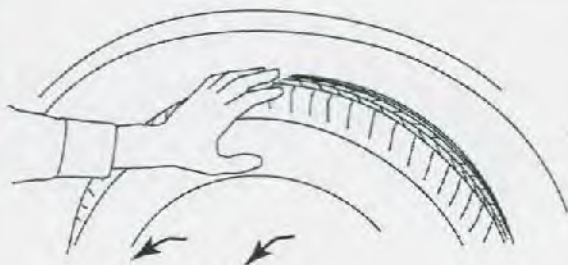

Soulever le véhicule et retirer la roue arrière à l'aide de la douille de xxmm.

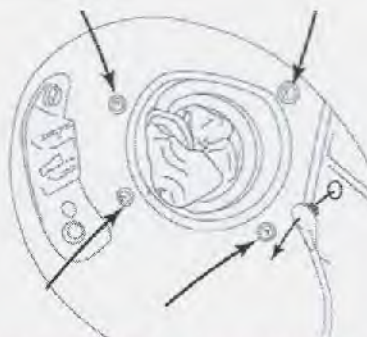

Insérer le chiffon dans le tuyau de remplissage. Retirer la longe du bouchon du réservoir de carburant. À l'aide du tournevis cruciforme, retirer les quatre vis du goulot de remplissage.

5

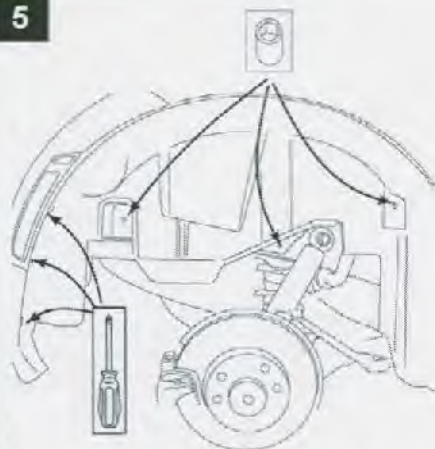

13mm

Retirer trois attaches à l'arrière de l'ouverture de la roue à l'aide d'un tournevis cruciforme. Utiliser une douille de 13mm pour retirer les trois attaches tel qu'illustré.

6

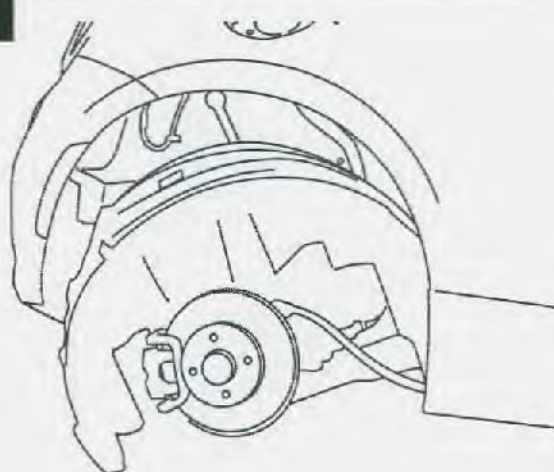

Abaisser l'aile pour accéder à la zone du réservoir de carburant.

7

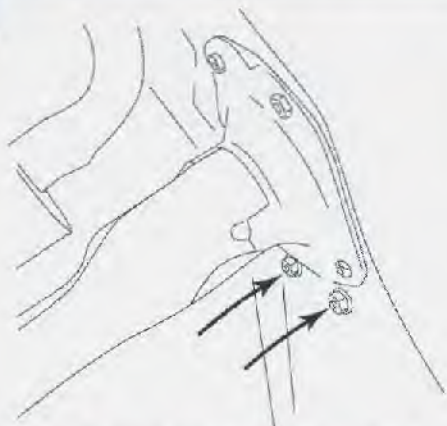

10mm

À l'aide d'une douille de 10mm, retirer les deux écrous maintenant la porte du réservoir en place.

8

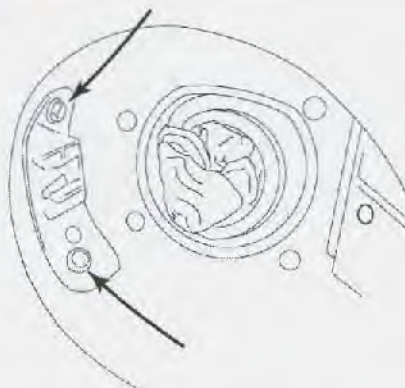

8mm

À l'aide d'une douille de 8mm, retirer les deux attaches retenant la gâche, et retirer celle-ci.

9

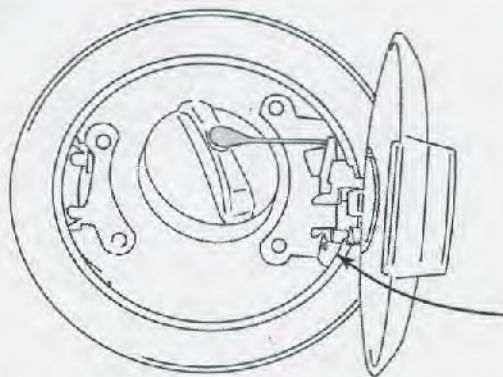

Rattacher la longe du réservoir de carburant à la porte du réservoir de carburant. La longe doit être acheminée derrière le support de fixation tel qu'illustré.

10

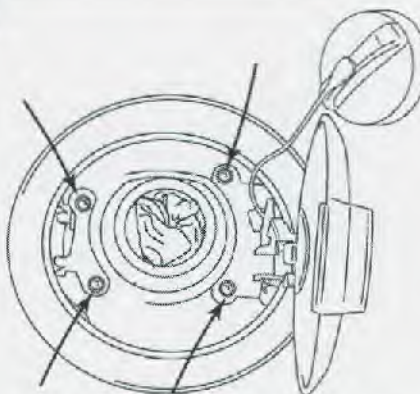

Insérer la porte du réservoir et la remettre en place à l'aide des 4 vis cruciformes retirées à l'étape 4. Serrer les vis à xx po-lb.

11

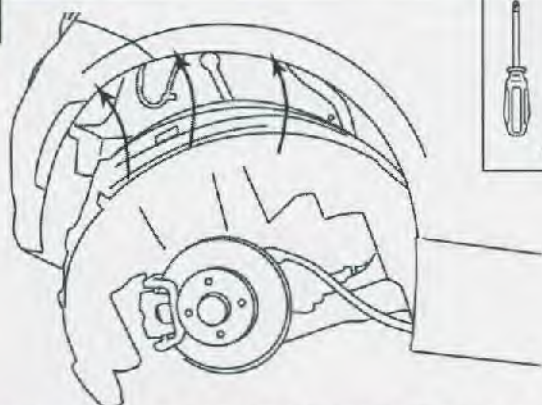

13mm

Réinsérer l'aile à sa position habituelle, et remettre en place les trois vis cruciformes et les trois attaches de 13mm retirées à l'étape 5.

12

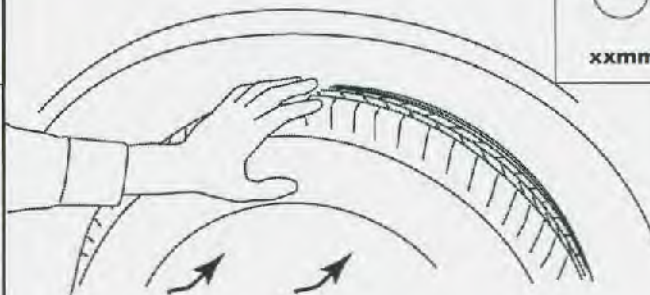

xxmm

Réinstaller la roue arrière. Serrer les écrous de la roue à xx pi-lb à l'aide d'une douille de xxmm et abaisser le véhicule.



# Fiat 500 Abarth – Tapa del Tanque de Gasolina - Cromada



**Tapa del Tanque de Gasolina**



**Llave de Torsión**



**Destornillador Phillips**



**xxmm**



**13mm**



**10mm**



**8mm**

**Cubos**

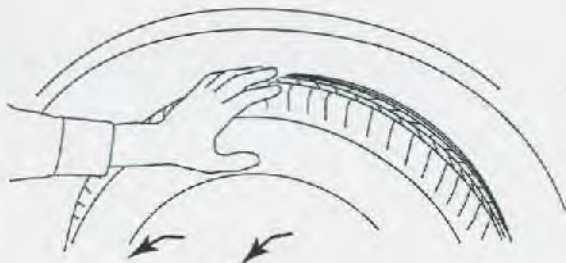

**Levante el vehiculo y retire el neumático trasera utilizando un cubo xxmm.**



**Coloque el trapo de tela en el tubo de llenado. Utilizando el destornillador Phillips remueva los tornillos del cuello de llenado.**

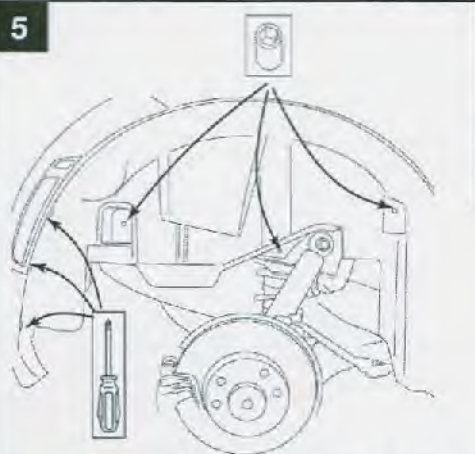

**Retire los tres tornillos en la parte posterior de la abertura de la rueda con un destrornillador Phillips. Utilice un cubo de 13mm para quitar los tres tornillos como se muestra en la grafica.**

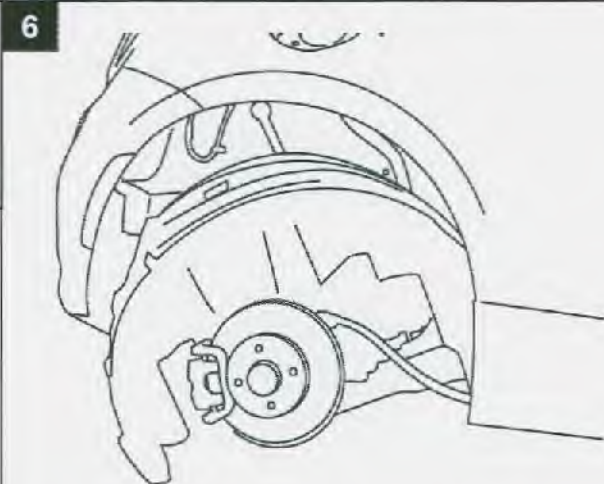

**Baje el forro del guardabarros inferior para obtener acceso a la zona de llenado de combustible.**

7

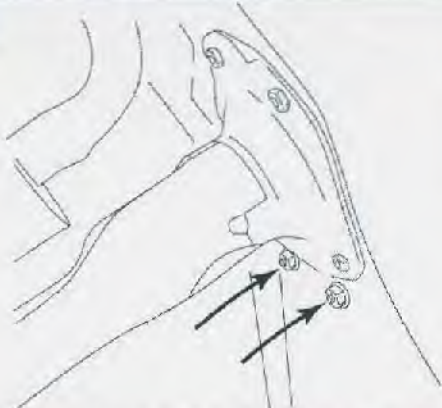

10mm

Utilizando un cubo de 10mm, quitar las dos tuercas que sujetan la puerta en su lugar.

8

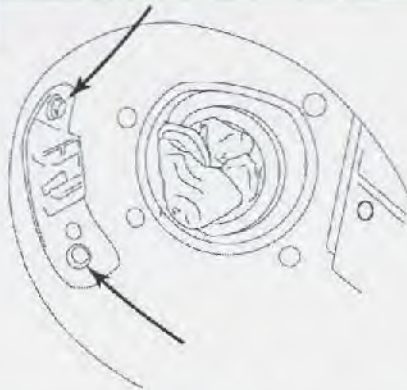

8mm

Utilizando un cubo de 8mm retire los dos tornillos que sujetan la placa de traba y retirela.

9

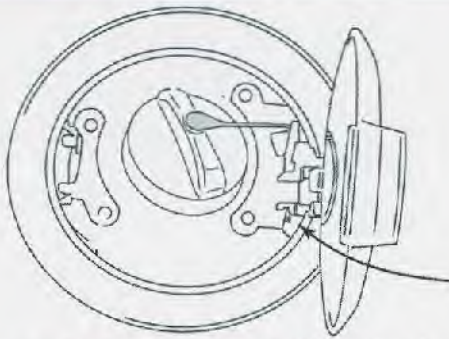

Vuelva a colocar correa de llenado de combustible a la puerta del depósito de combustible. La correa se va a encaminar detrás de soporte de montaje como se muestra en la gráfica.

10

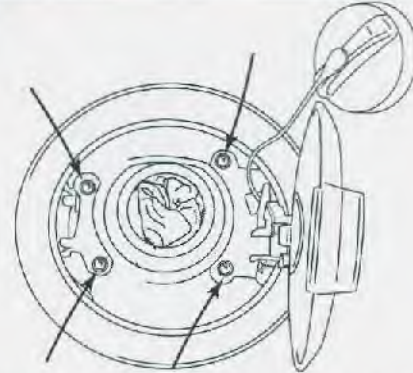

Inserte la puerta de carga y vuelva a conectar con 4 tornillos de cabeza phillips retirados en el paso 4. Apriete los tornillos hasta xx in-lbs.

11

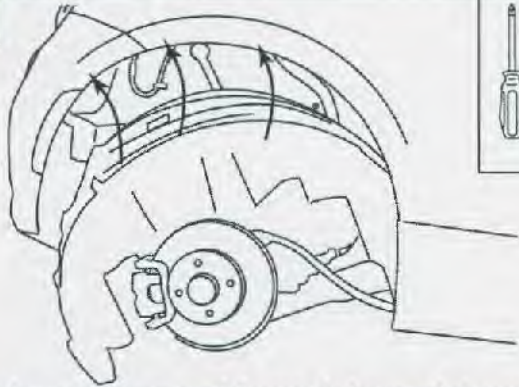

13mm

Vuelva a colocar el forro del guardabarro en su lugar y coloque los tres tornillos Phillips y los sujetadores de 13mm que retiró en el paso 5.

12

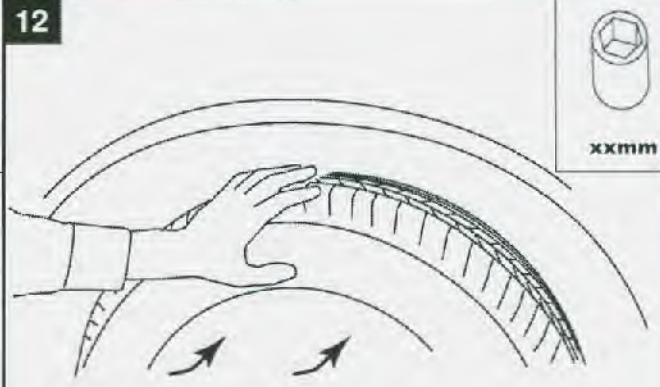

xxmm

Reinstale la rueda trasera. Apriete las tuercas a xx ft-lbs utilizando un cubo xxmm and baje el vehículo.